

Installation Instruction

Dimensions

TYPE	Dimensions (mm)		
	L	W	H
2 Feet	618	52.3	72
4 Feet	1179	52.3	72

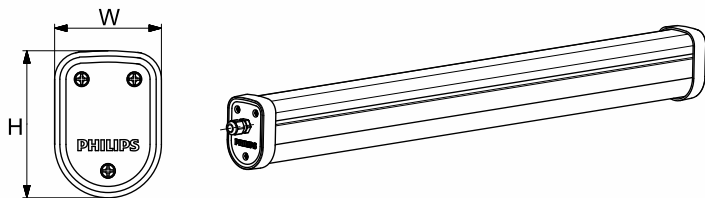

WT201C & WT200C

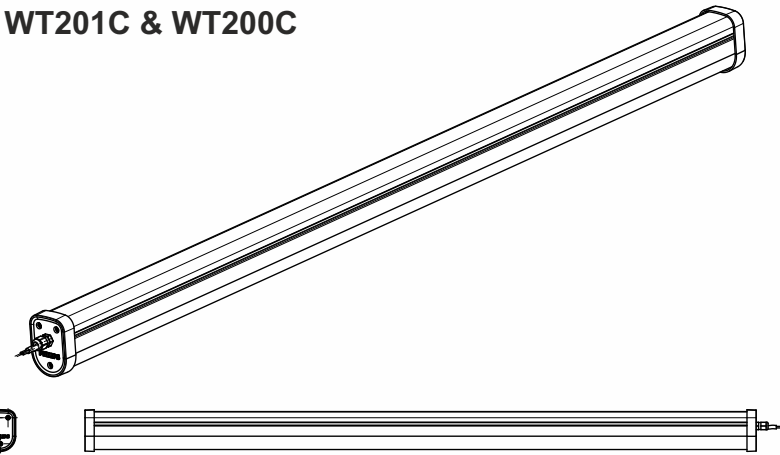

TYPE	: WT201C & WT200C
VOLTAGE	: 240 V, 50 Hz
IP CLASSIFICATION	: IP 65
NET WEIGHT (2 Feet)	: 0.7 Kg.
NET WEIGHT (4 Feet)	: 1.2 Kg.
APPLICATION	: INDUSTRIAL

PHILIPS

Surface Mounting

- 1 Take the luminaire out of Packing Box along with the accessory bag.

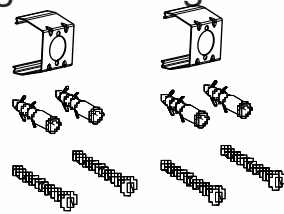

- 2 Fix mounting bracket onto ceiling (two anchor & two screw for single mounting bracket).

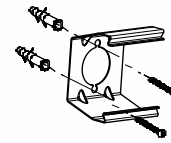

- 3 The distance of Surface mounting refer to distance "A".

TYPE	A (mm)
2 Feet	380±20
4 Feet	780±20

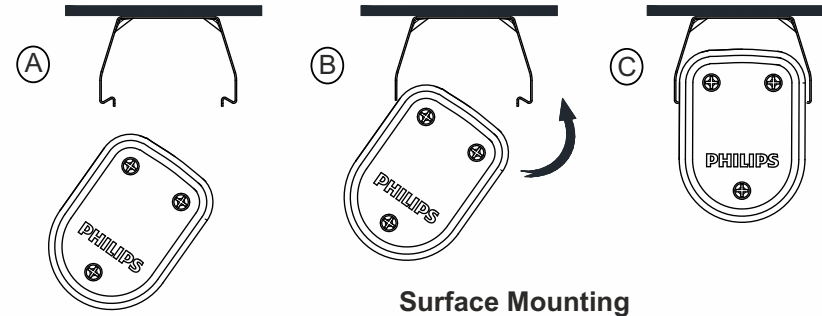
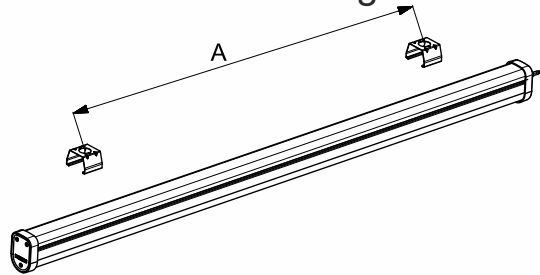

Surface Mounting

Suspension Mounting.



Fix the pole to ceiling surface and mount suspension bracket.

- 2 The distance of suspension mounting refer to "A".

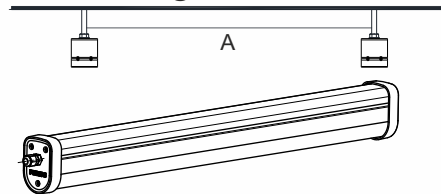

TYPE	A (mm)
2 Feet	380±20
4 Feet	780±20

- 3 Suspension mounting process

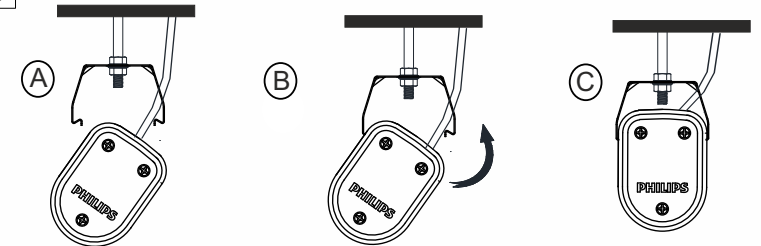

- 4 Switch off the main power supply.

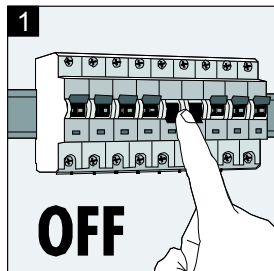

- 5 Connect to the main power supply.

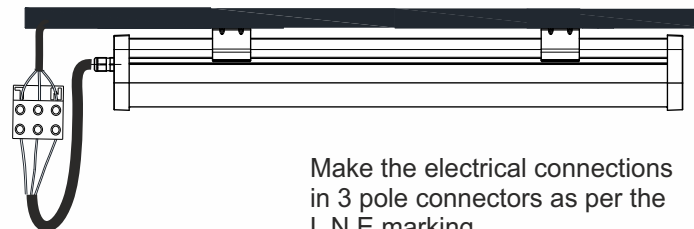

Make the electrical connections in 3 pole connectors as per the L N E marking.

- 6 CAUTION

1. The luminaire shall be installed by a qualified electrician and wired in accordance with the latest IEE electrical regulations or the national requirements.
2. Do not switch on before completing the installation.
3. The luminaire shall, under no circumstance, be covered with insulation mating or similar material.
4. Polyfilm should be removed before mounting

FAILURE OF PRODUCT DUE TO NON COMPLIANCE TO ANY OF THE ABOVE, VOIDS WARRANTY OF PRODUCT.